

REV.	DESCRIPTION	DATE

**NOTE**

- A. Insulator : High temp. plastic, UL 94V-0.
- B. Contact : Brass T=0.2 mm.
- C. Plating : Gold plated on contact area ; min 50u" Nickel plated all over ; min 100u" Sn on solder tail area.
- D. Shell : Steel SPCC T=0.30mm
- E. Shell Plating : min 60u" Nickel Plated.

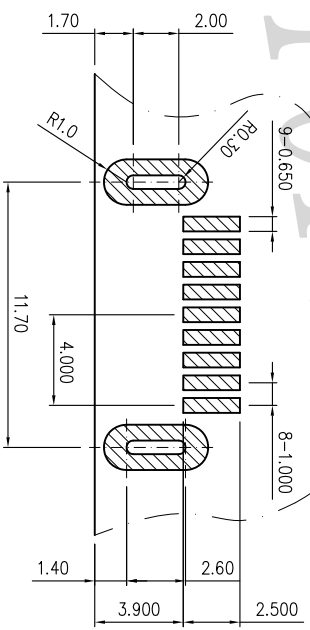
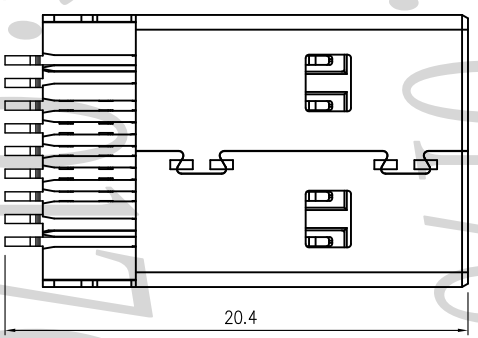
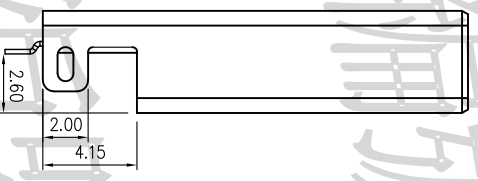
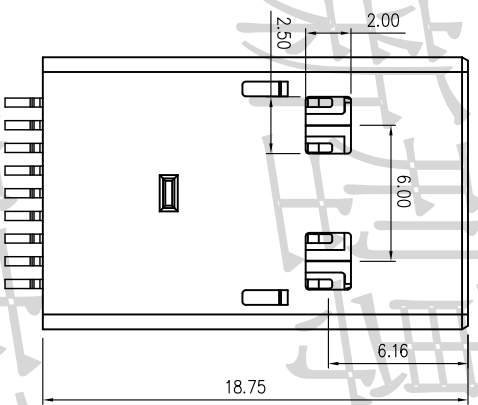
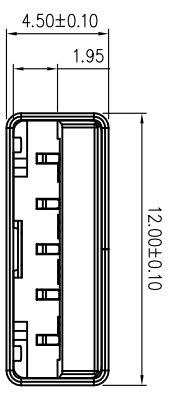

**Electrical :**

- A. Voltage: 30VAC(rms),
- B. Current: 1.8A
- C. Contact Resistance: 30mΩ (maximum)
- D. Insulation resistance: 100MΩ(minimum)
- E. Dielectric withstanding voltage: 100V AC
- F. Temperature: -55 °C to +105 °C
- G. Durability: > 1500 cycles.

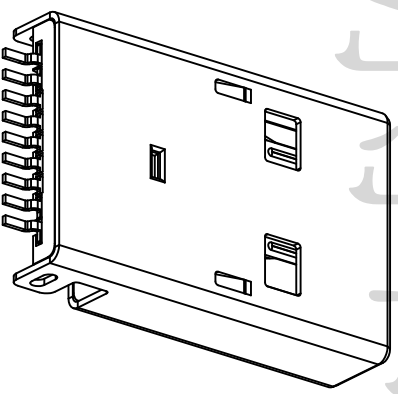

**RoHS**



TOLERANCE .X ±0.300 .XX ±0.200 .XXX±0.100		DRAWER <i>Chin Chuan Shiu</i>	
UNITS : mm		CHECK <i>Shi Tsung Shiu</i>	DESIGNED <i>Chin Chuan Shiu</i>
 UNITS : mm		APPROVAL <i>Shiu Tsung Shiu</i>	DATE 05 / 06 /2010
SCALE 3 : 1	SIZE A4	SHEET 1 OF 1	REV. A
 日亮電子科技有限公司 <i>Sun-Light Electronic Technologies Inc.</i>		NAME USB 3.0 Connector A Type SMT Series Offset 2.6 mm	
PART NO. USB3-A-P-260N-120B		DRAW NO. USB3-A-P-260N-120B	